

Plus 18



CAPACITY

18 TRAYS GN 1/1 H40 - H65

36 TRAYS GN 1/1 H20

36 TRAYS EN 60x40

+90
▼+3 | 80 kg | +90
▼-18 | 62 kg

PROGRAMS

Blast chilling Shock freezing

Low temperature cooking Proofing

Retherm. Fish sanitizing

Thawing Ice cream hardening

Pre-cooling Pre-heating.

Bottle cooling. Hot gas defrosting.

Cabinet drying. Cabinet sanitizing

VERSIONI

 **S** Plug-in air condensing unit

 **R** Without condensing unit

 **W** Plug-in water condensing unit

CONSTRUCTION FEATURES

Adaptive 7" touch screen controller

Internal and external construction in AISI 304 stainless steel.

Stainless steel feet adjustable in height.

Door gasket resistant to maximum and minimum temperatures.

Technical compartment placed above the cabinet.

Condensing unit placed in the technical compartment, removable and easily inspectable.

Electrical panel with connectors, removable and easy to inspect.

Multi-level adjustable stainless steel AISI 304 tray holder, suitable to hold GN 1/1 and EN 60x40 trays. Easily removable structure for cleaning operations.

Internal cell with rounded corners to facilitate cleaning operations.

CFC-free high density polyurethane insulation.

Evaporator with cataphoresis rust protection.

Left side door hinge.

Heated door perimeter to avoid frost formation.

FUNCTIONS

Probe cycles: the core probe temperature controls the cycle ensuring control and precision.

Time cycles: the set duration controls the cycle.

Timer cycles: 6 different timers can be set that automatically warn when the set duration is reached.

Cascade cycles with multiple probes installed: the cycle allows to set a different target temperature for each installed core probe.

Cascade cycles with one probe installed: this is a single-phase cycle with infinite time that allows different foodstuffs to be treated continuously without the need to act on the controller.

Quick start: it is possible to choose a preferred cycle for quick start.

Possibility to choose between factory preset cycles or to modify all the parameters of each cycle.

Customizable multiphase cycles.





Possibility to modify the parameters also during the current cycle.

Rename of the display probes, to better distinguish the temperatures of each food.





Recipe book for saving your favorite cycles.

HACCP data storage with the possibility of downloading via usb key.

STANDARD EQUIPMENT

-  n° 1 heated multi-point core probe.
-  AISI 304 stainless steel tray holder for GN 1/1 and EN 60x40.
-  Condensing tray, placed on the bottom of the machine.
-  Ozone generator for cabinet sanitization cycles.

OPTIONAL EQUIPMENT

-  Humidity generator.
-  Predisposition for 4 core probes (1 probe included).
-  Additional core probe.
-  Kit of casters.

Technical data	S	R	W
Cooling capacity (Evap. -10°C / Cond. 45°C)	7626 W	-	7626 W
Cooling capacity requested	-	7626 W	-
Liquid line	-	3/8" [10] mm	-
Suction line	-	1/2" [12] mm	-
Condensation	self-contained air	remoto	autonomo acqua
Refrigerant gas	R452A	R452A	R452A
GWP	2141	2141	2141
Climate class	4	4	4
Power supply (Ph / Volts / Hz)	380-420/3N/50	220-240/1N/50	380-420/3N/50
Max. power consumption cold cycles	4888 W - 10.28 A	555 W - 2.96 A	4708 W - 9,46 A
Max assorbimento elettrico cicli caldo (optional umidità)	3310 W (3310 W)	3310 W (3310 W)	3310 W (3310 W)
Blast chilling (+90 °C, +3 °C)	80 kg	80 kg	80 kg
Shock freezing (+90°C, -18°C)	62 kg	62 kg	62 kg
Internal dimensions (wxpxh)	650 x 433 x 1440 mm	650 x 433 x 1440 mm	650 x 433 x 1440 mm
External dimensions (wxpxh)	750 x 864 x 2201 mm	750 x 864 x 2201 mm	750 x 864 x 2201 mm
Capacity (liter)	405 L	405 L	405 L
Packaging dimensions	800 x 890 x 2368 mm	800 x 890 x 2368 mm	800 x 890 x 2368 mm
Packing volume	1.7 m ³	1.7 m ³	1.7 m ³
Gross weight	273 kg	255 kg	273 kg

EN22042			
+65°C +10°C	kWh/Kg	0,097	+65°C -18°C
	Min.	97	
	Kg	75	
+65°C -18°C	kWh/Kg	0,299	+65°C -18°C
	Min.	266	
	Kg	52	

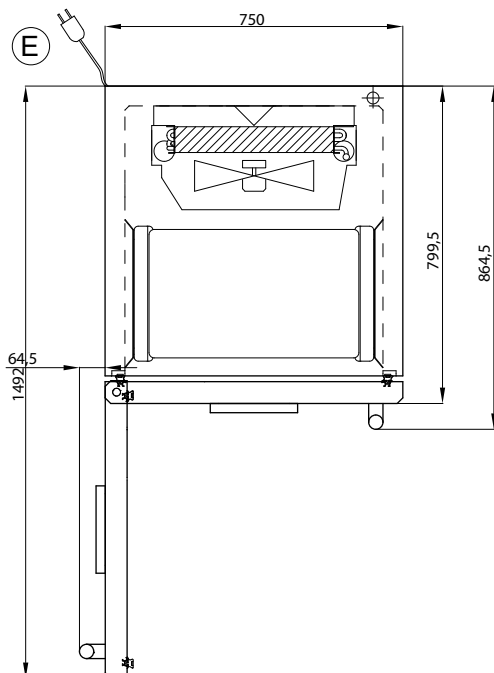
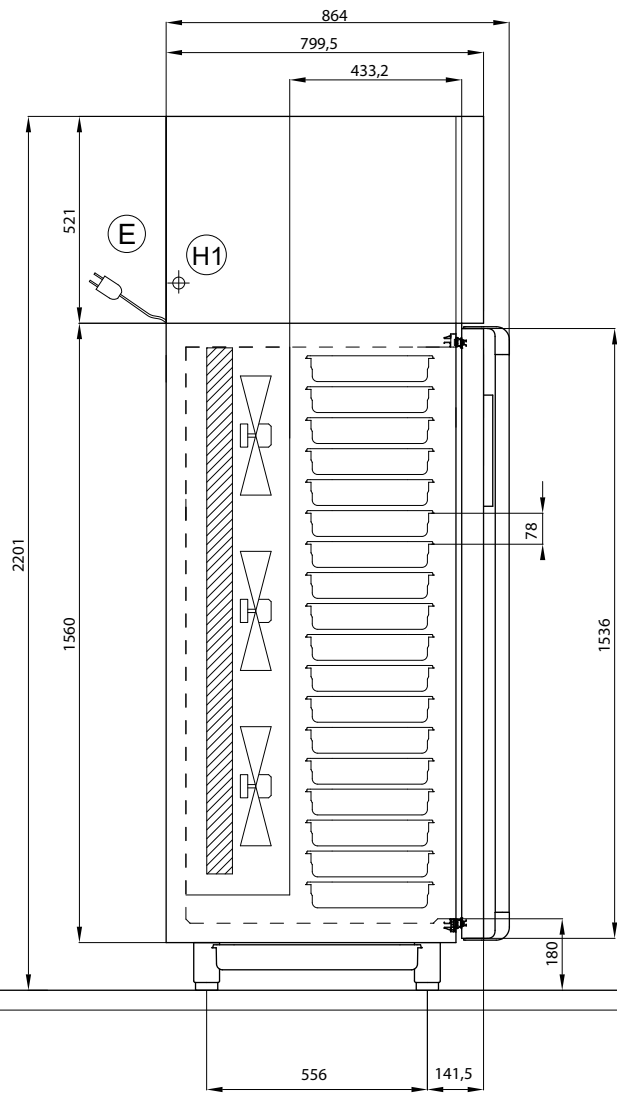
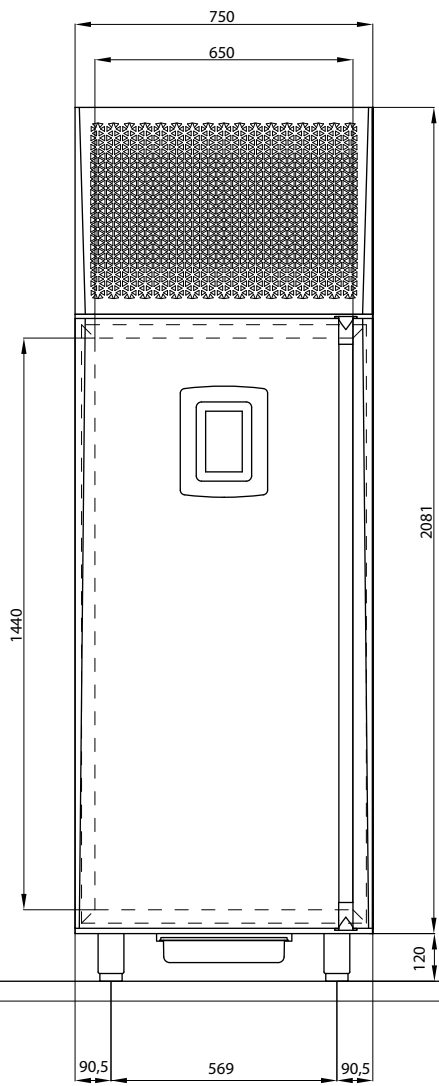

 H MIN 120
H MAX 165

 CONNESSIONE ELETTRICA
ELECTRICAL CONNECTION

GASTRONOMIA / GASTRONOMY

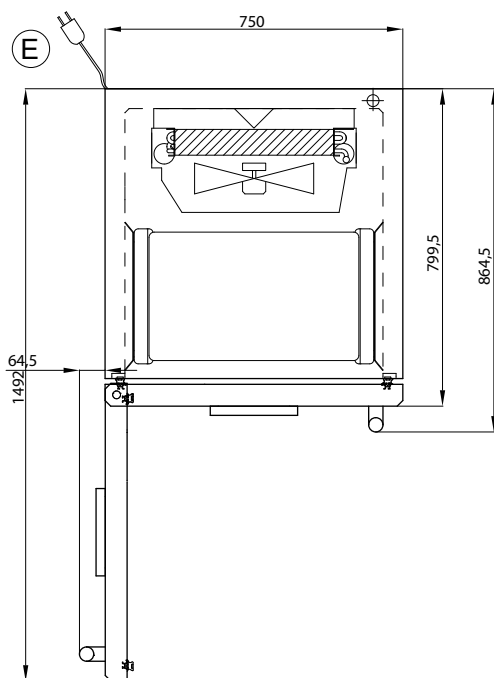
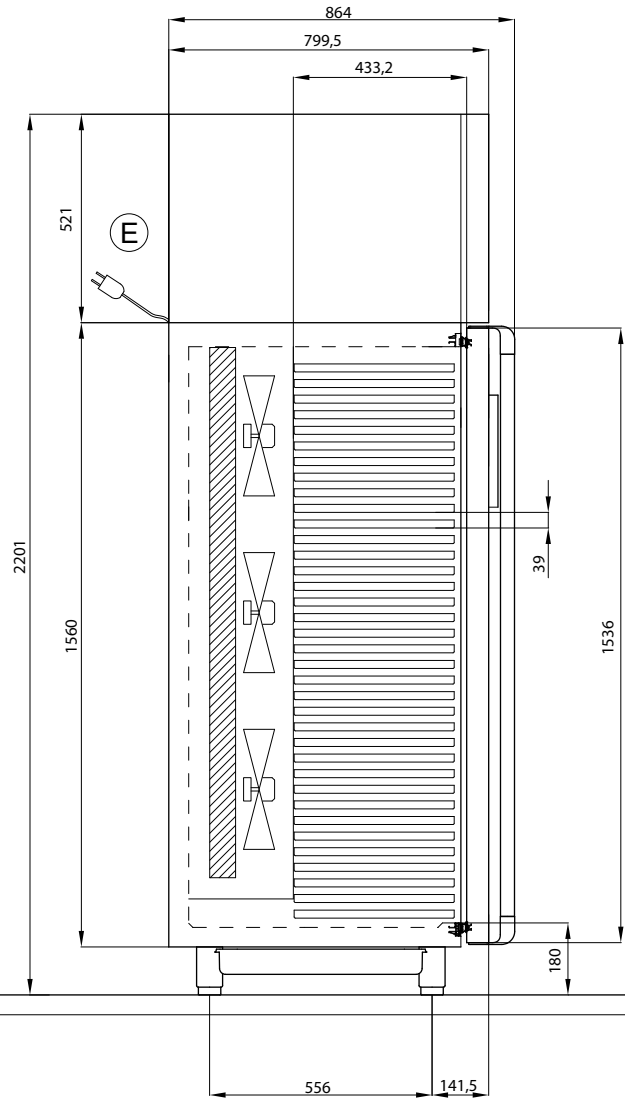
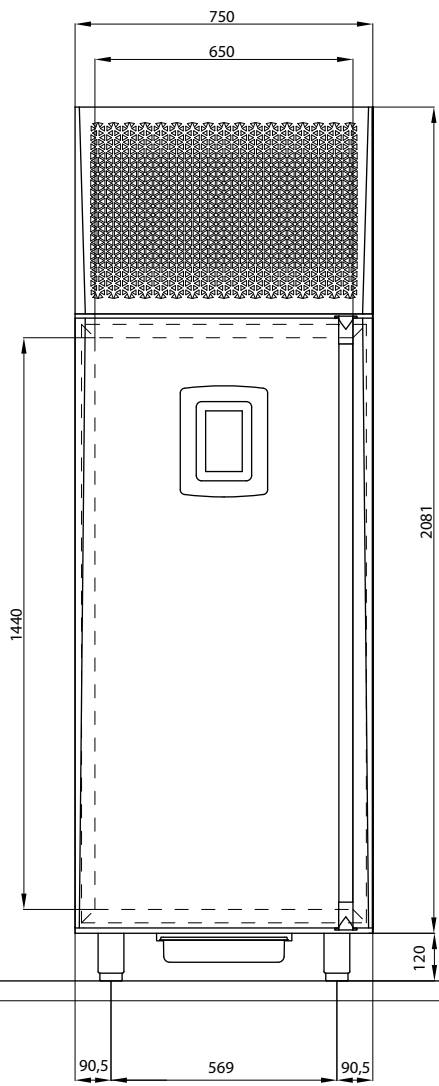

 H MIN 120
H MAX 165

 CONNESSIONE ELETTRICA
ELECTRICAL CONNECTION

PASTICCERIA / PASTRY

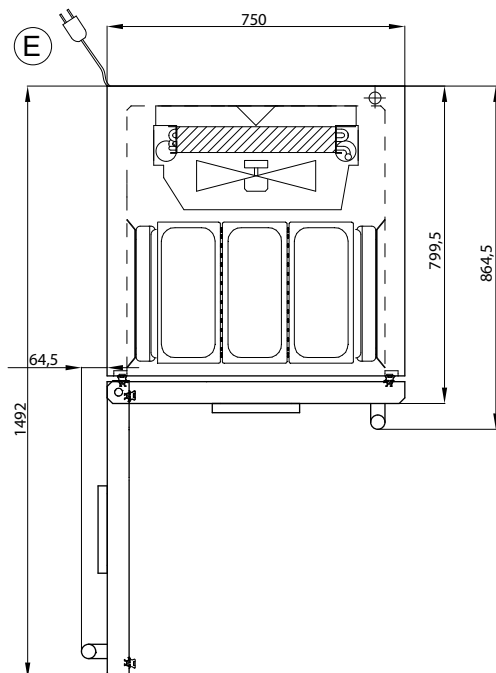
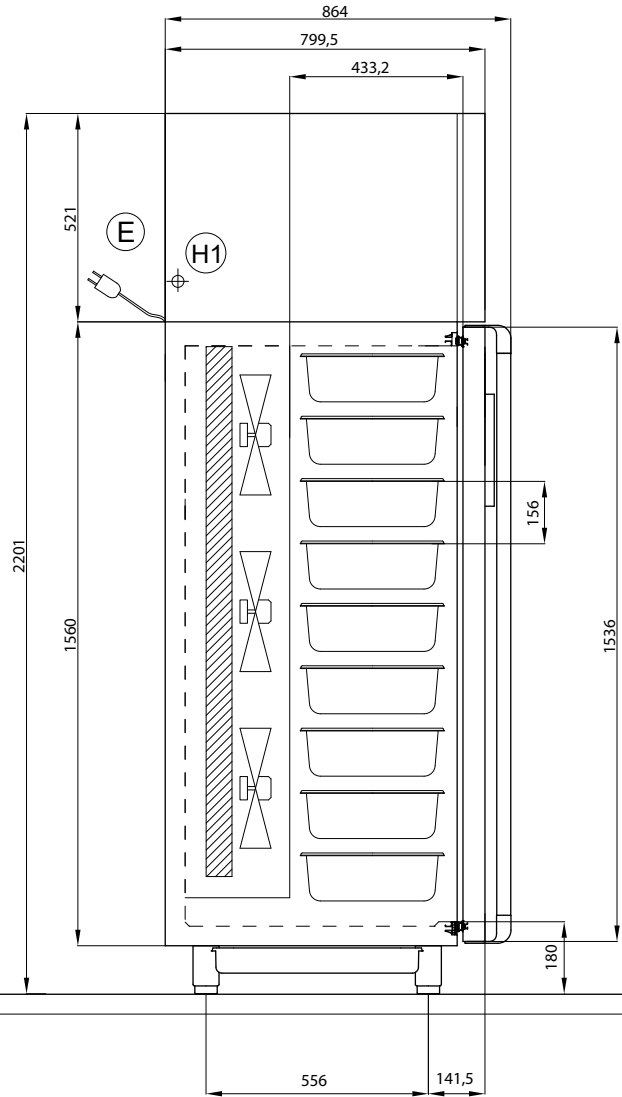
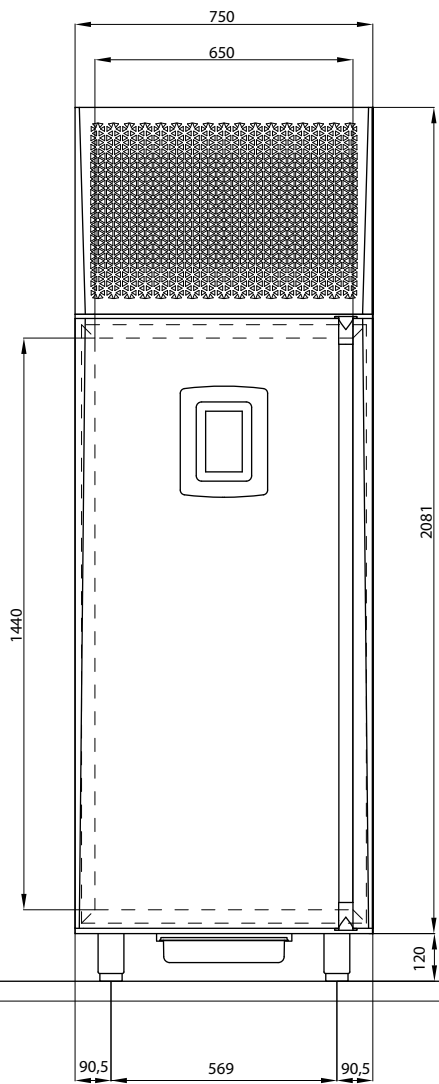

 H MIN 120
H MAX 165

 CONNESSIONE ELETTRICA
ELECTRICAL CONNECTION

GELATO / ICE CREAM